



Ravaglioli

COMPANY WITH QUALITY MANAGEMENT
SYSTEM CERTIFIED BY DNV
= ISO 9001:2008 =

Pachet Geometrie roti Ravaglioli

Elevator 4 coloane-RAV4406

CRIC TRAVERSA 2T MANUAL-J20NX

APARAT MASURAT SI REGLAT GEOMETRIE
RAVTD5080WS

Pret special: 11500 €

RAV
SERIES



Ravaglioli S.p.A. este una dintre companiile de top din lume în industria de echipamente pentru atelierele auto. Producător de top în Europa de echipamente și printre principalii producători de aparate pentru dezatant și echilibrat anvelope precum și echipamente de testare (testare vehicule și aliniere roți).

Inițiată în anul 1958 ca producător de echipamente de atelier reparații, Ravaglioli a continuat dezvoltarea tuturor aspectelor legate de ridicarea vehiculului (autoturisme și vehicule utilitare), fără întrerupere până în prezent.

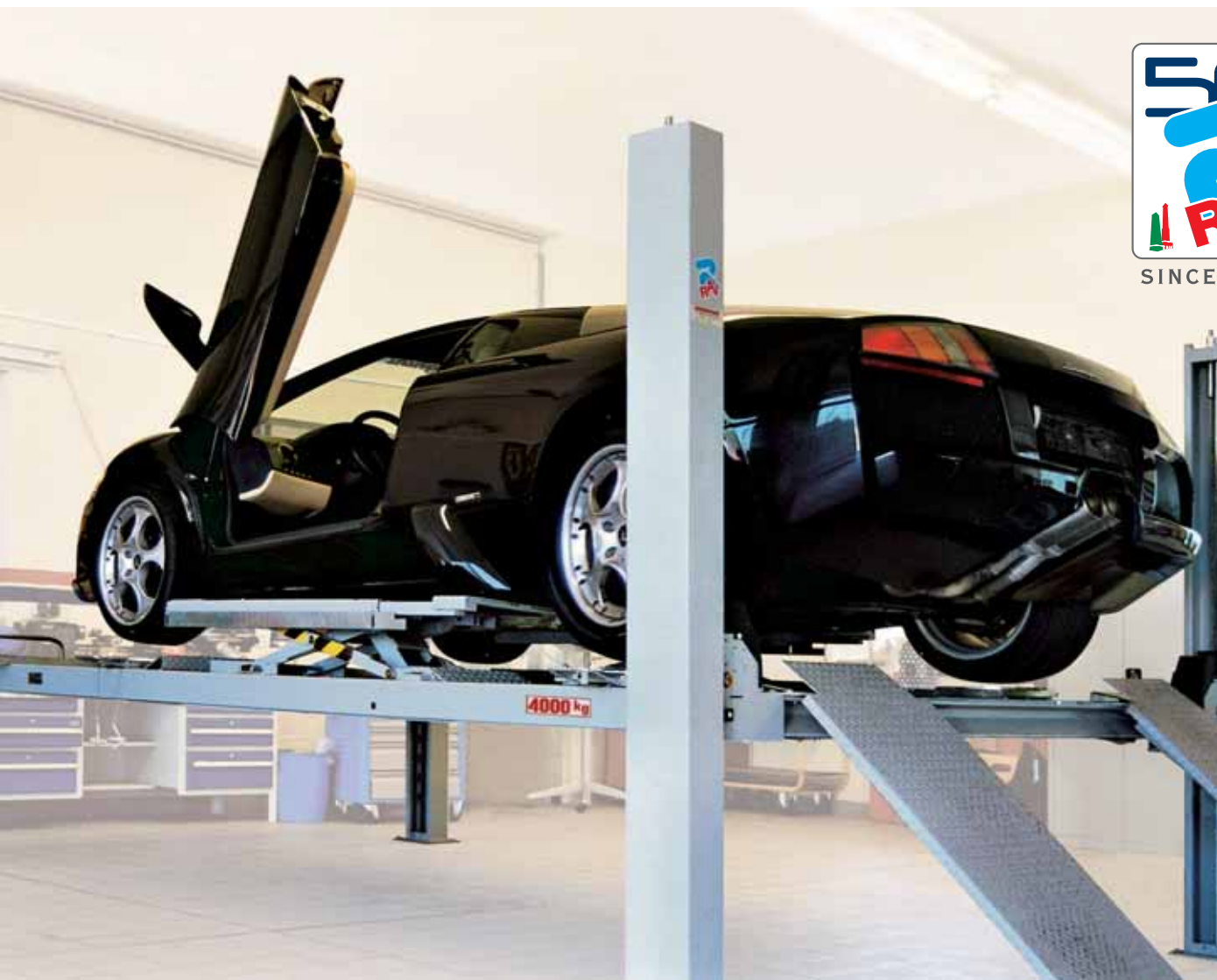

SINCE 1958

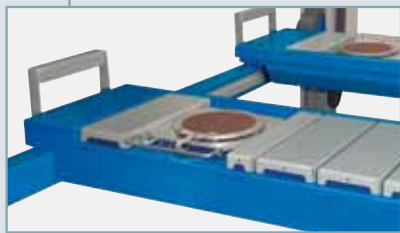
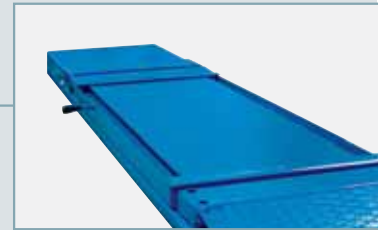

RAV 4406E / 4000 kg

**Elevator electro-hidraulic 4 coloane
Pregatit pentru geometrie - Ravaglioli**

Descriere:

Elevator 4 coloane, electro-hidraulic
Pentru autoturisme si autoutilitare mici
Sistem de blocare mecanic
Pregatit pentru aparat de verificat
geometria rotilor

Date tehnice:

Sarcina elevator max: **4000 kg**
Timp de ridicare/coborare aprox. 50/45 sec
Putere motor 2.6 kW
Alimentare 400 V

Conditii de instalare:

Fundatie, minim 160 mm adincime,
dublu armata , calitate beton B250

RAV 4406E

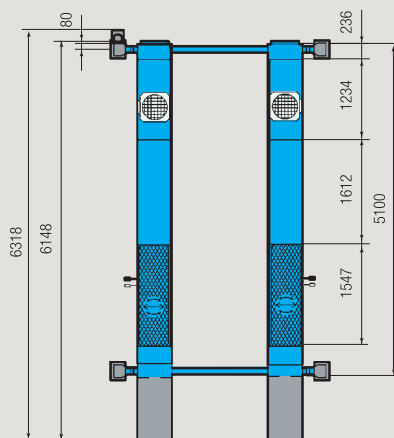
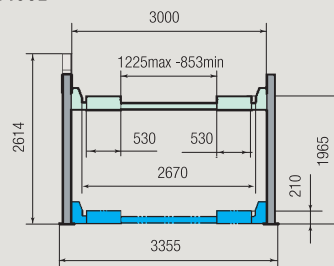

**J20NX Cric traversa 2000kg pentru elevator
4 coloane Ravaglioli**

Operare cu pompa manuala
Miscarea de translatie se desfasoara
pe role elastice

Distanța între rampe
min/max: 816-1134mm

Distanța minimă preluare 78mm

Distanța maximă ridicare 433 mm

Sistem siguranța coborare "doua maini"

J20 NX - 2.000 kg



OPTIONS

S 505 A1
(4 x kit)

H= 200 mm



S 505A5
S 505A6
S 505A7
(4 x kit)

H= 120 mm
H= 40 mm
H= 20 mm





TD 5080WS Bluetooth

EASY DATA



STANDARD

All included



RAVTD5080WS - Aparat verificat si reglat geometrie - Ravaglioli

8 senzori CDD cu transmisie prin Bluetooth intre cititoare fata si unitatea de control. Mobilitate maxim între diferitele posturi de lucru datorit lipsei de cabluri i de orice structur fix .

1 unitate completa dotata cu computer

Monitor 19"

Tastatura

Imprimanta color

Incarcator pentru baterii fast charge

2 capete de citire axa fata

2 capete de citire axa spate

1 imobilizator coloana directie

1 imobilizator pedala frana manual utilizare

Set 2 perchei clesti prindere 4 puncte pentru jante 10-24"

2 placi rotative mecanice

Baza de date cu peste 90.000 de vehicule cu posibilitatea de a mai introduce inca 20.000 de vehicule

Spoiler Program



Permite verificarea geometriei vehiculelor echipate cu spoiler

QUICK RUN OUT



Program special pentru realizarea unei compensari rapide prin miscarea vehiculului cu numai 30° fata de pozitia initiala.

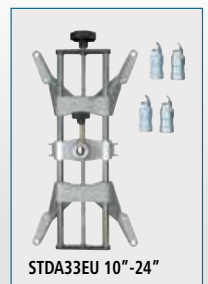
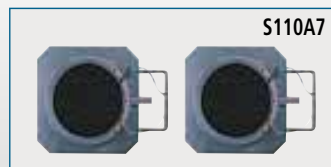

Contact: Email: tools@autototal.ro
Tel: +40 314 326860
www.service-total.ro